

Catalog Number
Notes
Type



Centralized
Lighting Inverter

APPLICATION

- Operates LED, incandescent, magnetic and electronic ballast fluorescent, high power factor compact fluorescent and high intensity discharge (HID) luminaries.
- Schools, Sports Facilities, Universities, Mass Transit, Warehouses.
- Provides conditioned, uninterruptible power for other types of critical loads.
- Consult factory for non-lighting load applications.

SAFETY LISTINGS

- UL 924 Emergency Lighting Equipment
- UL 924 Auxiliary Lighting Equipment
- NFPA 101
- NFPA 111

WARRANTY

- Standard warranty: (requires execution of factory start-up within 120 days of shipment) BritePath will provide parts and on-site labor for the first 12 months following start-up of the product, and parts only for an additional 12 months. If factory start-up is not executed within 120 days of shipment, BritePath will provide a parts warranty for 24 months from the date of shipment.
- Extended warranty available: consult factory for extended warranty and service option.

DESIGN

- Free standing, NEMA 1 enclosure with lockable control access panel.
- Double conversion, no interruption output.
- Solid state pulse width modulated inverter.
- Internal, automatic static bypass switch.
- Internal, make before break maintenance by-pass.
- Standard, UL 924 compliant, 90 minute battery back up.
- Microprocessor control and diagnostic system.
- LCD color touch screen display.
- User programmable automatic testing.
- RS 232 Communications Port.
- Fault annunciating local audible alarm.
- Normally open contacts for status & alarm communications
- Current limiting start sequence.
- Automatic low battery voltage disconnect.
- Optional output circuit breakers and circuit breakers with trip alarm
- Optional normally off load with time delay.
- Optional Web Based Communications.
- Optional Seismic certification.
- Optional Remote Annunciator.
- 87% throughput efficiency, 85% emergency efficiency.
- Operating temperature range 32°F (0°C) to 104°F (40°C)1.
- Storage temperature -4°F (-20°C) to 122°F (50°C).
- Fault current rating 42 kAIC.
- Audible noise less than 50 dB at 3 ft on "A" weighted scale.

ORDERING INFORMATION

Example: PSU B7.0S N5NXB20 W

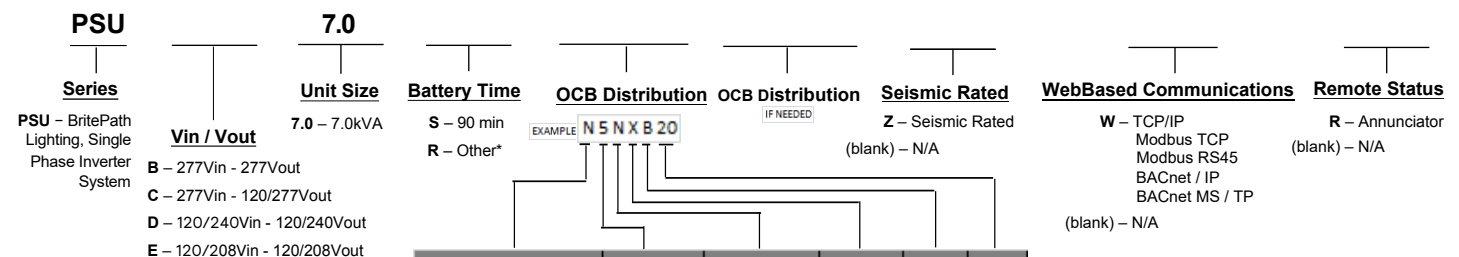

*Contact factory for projects requiring alternative battery run times, such as 10 and 20 minutes.

OUTPUT TYPE	BREAKER(s)	Trip Alarm	Pole	Volts	Amps
N-NORMAL ON	0-20	N-No Alarm (up to 20)	X-1P	A-120	15
T-TIMED NORMAL OFF		A-Trip Alarm (up to 10)	Y-2P	B-277	20
			N-N/A	E-208	30
				D-240	N-N/A



ELECTRICAL - INPUT

- Input voltage operating range +10 / -15%
- Input power factor correcting to 0.99.
- Frequency range 60 Hz, ±2.5 Hz.
- Input harmonic current distortion < 5% THD.
- UL1449, ANSI/IEEE C62.41 surge suppression.

ELECTRICAL - OUTPUT

- Sine wave output.
- Voltage regulation ±2%.
- Frequency regulation - synchronized to utility, free running 60 Hz, ±0.5%.
- Output voltage distortion maximum 3% THD with linear load.
- Load power factor capability 0.7 lead to 0.7 lag.
- Overload capability 125% for 10 seconds.

Vin	Input Breaker	Input Amps	Vout	Output Amps
277V	50A	36.6A	277V	25.3A
120/240V	70A	42.4A	120/240V	58/29A
120/208V	70A	49.1A	120/208V	58/33.7A
			120/277V	58/25.3A

BATTERY

- Maintenance free, sealed lead calcium battery with a design life up to 10 years, and optimum operating range of 65°F (19°C) to 85°F (30°C).¹
- 4 Stage, temperature compensated charger, 1% ripple.
- Recharge time UL924 / NFPA101 compliant (24 hours).
- Bus voltage 120VDC.

DIMENSIONS

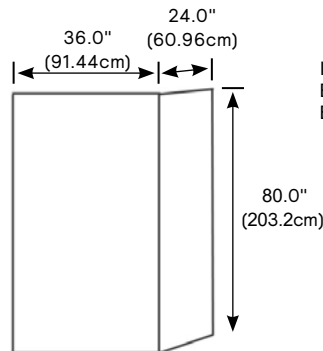

Inverter Weight: 950lbs
 Battery Weight: 1325lbs
 BTUs / HR Full load: 3,345

Footnote

¹ Optimum operating temperature of batteries is 77°F (25°C).
 Temperatures above 85°F (30°C) adversely impact battery life.

Check List

Catalog No: _____

VA Rating: _____

Battery Type: Maintenance free, Sealed Lead Calcium

Operating Time: 90 Min.

Input: _____ VAC, Single Phase

Output: _____ VAC, Single Phase

Output Circuit Breakers:

	Normally	Timed Normally	Trip Alarm	
Qty: ___ AC Volts: _____ Amps: _____	ON <input type="checkbox"/>	OFF <input type="checkbox"/>	YES <input type="checkbox"/>	NO <input type="checkbox"/>
Qty: ___ AC Volts: _____ Amps: _____	ON <input type="checkbox"/>	OFF <input type="checkbox"/>	YES <input type="checkbox"/>	NO <input type="checkbox"/>
Qty: ___ AC Volts: _____ Amps: _____	ON <input type="checkbox"/>	OFF <input type="checkbox"/>	YES <input type="checkbox"/>	NO <input type="checkbox"/>
Qty: ___ AC Volts: _____ Amps: _____	ON <input type="checkbox"/>	OFF <input type="checkbox"/>	YES <input type="checkbox"/>	NO <input type="checkbox"/>

On Site Factory Start Up (FSU) included

Optional Extended Warranty (EXT): Yes No

Description: _____

(FSU) Factory Start-Up: Includes on site start up by factory authorized technician, system training and demonstration during same site visit. Also provides 12 months of on site warranty service.

OPTIONAL (EXT) Extended Warranty: Will increase FSU on site, 12 month warranty period to a 24 month warranty period.